

# Data Sheet



Article number: 021300705020

Description: Sealing Clamp S 20 W5

## Measures

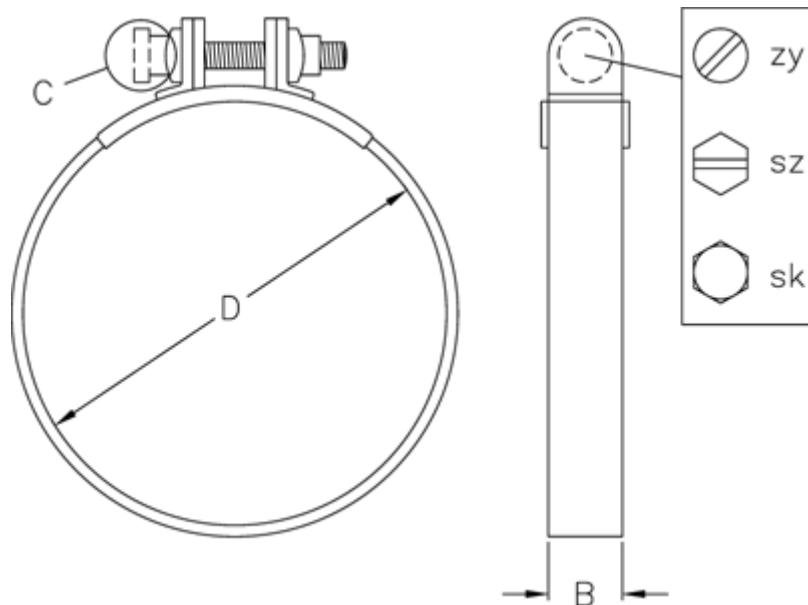

C (screw type) = SZ

Diameter D = 20

Width B = 12